

# MILL STEEL

## F R A M I N G

[www.millsteel framing.com](http://www.millsteel framing.com) | 800.247.6455 | [info@millsteel.com](mailto:info@millsteel.com)



The Dillon Buckhead - Atlanta, GA

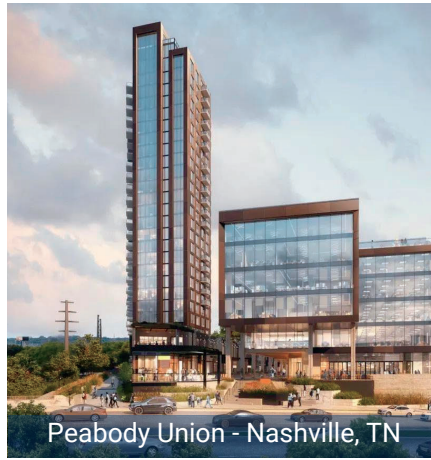

Peabody Union - Nashville, TN



HALL Park - Frisco, TX

## ABOUT US

Mill Steel Framing offers a variety of metal framing products for the commercial and residential construction industries. We are dedicated to providing excellent service, quality products, and reliable delivery. Headquartered in Grand Rapids, MI, with regional processing and distribution facilities in Jeffersonville, IN, Birmingham, AL, and Houston, TX.



## WHAT WE OFFER

### STRUCTURAL STUDS

Gauge: 12 - 20  
Web: 2 1/2" - 12"  
Flange 1 3/8" - 3 1/2"

### ProSTUD® & ProTrak®

Gauge: 20 - 25  
Web: 1 5/8" - 6"

### ACCESSORIES

*Full line including, but not limited to:*

- |                  |                           |
|------------------|---------------------------|
| Angles           | Cold Rolled Channel       |
| Strapping        | Slotted Slip Track        |
| Furring Channels | Resilient Furring Channel |
| USG Shaftwall    | Full Line of Clips        |

# LEED® CERTIFIED



Steel framing components manufactured by Mill Steel Framing may qualify for the following LEED® credits:



## **Materials and Resources: Credit 2.1 & 2.2 Construction - Waste Management**

Mill Steel Framing metal framing is 100% recyclable.



## **Materials and Resources: Credit 4.1 & 4.2 - Recycled Content**

Mill Steel Framing metal framing products and accessories contain approximately 25.5% post-consumer and 6.8% pre-consumer recycled content.



## **Materials and Resources: Credit 5.1 & 5.2 - Regional Materials**

Mill Steel Framing products will be produced at our facilities in Jeffersonville, IN and Birmingham, AL.

### **Our raw materials originate from the following locations:**

- AK Steel - Middletown, OH
- Cleveland Cliffs - Burns Harbor, IN
- Nucor Steel - Georgetown, SC
- Steel Dynamics - Sinton, TX
- United States Steel - West Muffin, PA

<http://www.usgbc.org/leed>

\*USGBC and its related logo are trademarks owned by the U.S. Green Building Council and are used by permission.

# MASTERSPEC

Mill Steel Framing is listed on Deltak Masterspec, the leading specification platform for building and construction professionals. Scan the QR code below to view our products.

Find us in

**MasterSpec**<sup>®</sup>

a product of The American Institute of Architects



# CERTIFIED WBENC

Mill Steel is proudly certified as an Exceptional Women's Business Enterprise (EWBE) by the Women's Business Enterprise National Council (WBENC).



**WBENC**  
WOMEN'S BUSINESS ENTERPRISE  
NATIONAL COUNCIL

JOIN FORCES. SUCCEED TOGETHER.

hereby grants

## National Women's Business Enterprise Certification

to

The Mill Steel Co. DBA Mill Steel Company, Mill Steel Framing, Steel Plus Solutions, Mill Steel,  
Cleveland Metal Exchange

who has successfully met WBENC's standards as a Women's Business Enterprise (WBE).  
This certification affirms the business is woman-owned, operated and controlled and is valid through the date herein.

Certification Granted: January 19, 2022  
Expiration Date: January 19, 2027  
WBENC National Certification Number: WBE2200118







WBENC National WBE Certification was processed and validated by Great Lakes Women's Business Council, a WBENC Regional Partner Organization.



Authorized by Michelle Richards, President  
Great Lakes Women's Business Council



NAICS: 423510  
UNSPSC: 30130000, 73121507, 73121601



# MATERIAL CERTIFICATION:

## CODE APPROVALS AND PERFORMANCE

We certify and guarantee that materials supplied by Mill Steel Framing meet or exceed the ASTM International Standards and comply with the requirements of the Federal Specifications for each product as indicated.

### ProSTUD<sup>®</sup> DRYWALL FRAMING STANDARDS:

- AISI S100-16 - North American Specification for the Design of Cold-Formed Steel Structural Members
- AISI S220-15 - North American Standard for Cold-Formed Steel Framing Nonstructural Members
- Section A4 Material - Chemical & mechanical requirements (Referencing ASTM A1003/A1003M)
- Section A5 Corrosion Protection (Referencing ASTM A653/A653M)
- Section A6 Products - Thickness, shapes, tolerances, identification
- Section C Installation (Referencing ASTM C754)

### MILL STEEL NONSTRUCTURAL FRAMING COMPLY WITH:

- IBC-2018, 2021 - International Building Code
- Intertek CCRR-0207
- SFIA (Steel Framing Industry Association) Code Compliance Certification Program
- UL 263 "Fire Tests of Building Construction and Materials"
- ASTM E119 - Standard Test Methods for Fire Tests of Building Construction and Materials
- ASTM E72 - Standard Test Methods of Conducting Strength Tests of Panels for Building Construction
- ASTM E90 - Standard Test Method for Laboratory Measurement of Airborne Sound Transmission Loss of Building Partitions and Elements

### MULTIPLE UL<sup>®</sup> DESIGN LISTINGS FOR PROSTUD:

- Over 50 UL Designs. See UL file number R26512 for additional information.
- UL<sup>®</sup> and UL<sup>®</sup> Deisgn are service marks of Underwriters Laboratories, Inc.

### ASTM INTERNATIONAL DESIGNATIONS:

<b>ASTM C 955</b>	Standard specification for loadbearing (transverse and axial), steel studs, runners (tracks), and bracing or bridging for screw application of gypsum panel products and metal plaster bases.
<b>ASTM A 1003</b>	Standard specification for steel sheet, carbon, metallic, and nonmetallic coated for cold-formed framing members.
<b>ASTM C 645</b>	Standard specification for non-structural steel framing members.
<b>ASTM A 653</b>	Standard specification for steel sheet, zinc-coated (galvanized) or zinc-iron alloy coated (galvannealed) by the hot-dip process.

Products are designed in accordance with American Iron & Steel Institute (AISI) Specification for the Design of Cold-Formed Steel Structural Members, latest addition and addenda.

# DRYWALL FRAMING

## WHAT IS AN EQ DRYWALL STUD?

Gauge equivalent drywall framing must meet the minimum performance requirements of conventional drywall framing as defined by the Steel Framing Industry Association (SFIA). The industry's "EQ" product of choice, ProSTUD,<sup>®</sup> employs roll-forming and steel-making technology, exceeding the performance of conventional drywall framing for allowable moment and screw connection strength. When comparing drywall framing systems, it is important to keep in mind Life Safety, System Performance and Connections. The ProSTUD Drywall Framing System provides peace of mind for all three important functions by providing the right selection of products and product data for every application.

## ProSTUD<sup>®</sup> PROFILE INFORMATION

Web Widths: 1-5/8", 2-1/2", 3-1/2", 3-5/8", 4", 5-1/2", & 6"

Flange: 1-1/4"

Lip: Varies by stud size



## MATERIAL THICKNESSES:

- ProSTUD 25 / 15mil (25ga. EQ) 50ksi
- ProSTUD 20 / 18mil (20ga. EQ) 70ksi
- ProSTUD 30MIL 33ksi
- ProSTUD 33MIL 33ksi

### ProSTUD Profile

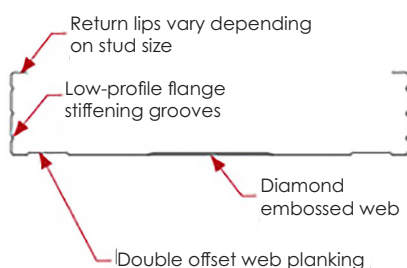

### Shipping / Stacking



### Drywall Joint

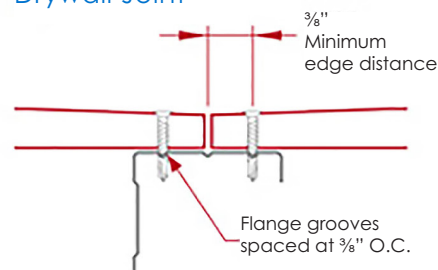

## ProTRAK

- Web Widths: 1-5/8", 2-1/2", 3-1/2", 3-5/8", 4", 5-1/2", and 6"
- Legs: 1", 1-1/4", 1-1/2", 2", 2-1/2", and 3"

## MATERIAL THICKNESSES:

- ProTRAK 25 / 15mil (25ga EQ) 50ksi
- ProTRAK 20 / 18mil (20ga EQ) 50ksi
- ProTRAK 30MIL 33ksi
- ProTRAK 33MIL 33ksi

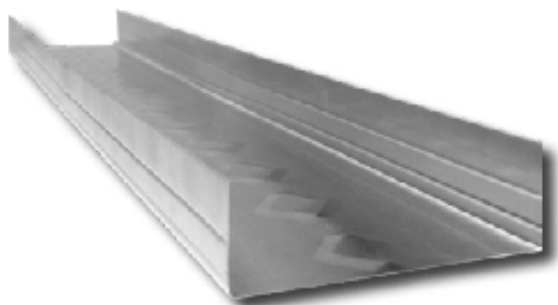

## LIFE SAFETY

Life Safety is the primary concern and duty of all construction and design professionals. For interior drywall framing members, bending strength is the criteria most important to the strength of a wall or ceiling. AISI defines bending or flexural strength by Allowable Moment. The corresponding chart compares the bending strength of ProSTUD and conventional drywall studs.

## SYSTEM PERFORMANCE

Given ProSTUD's strength and versatility, it is important to know the performance of the ProSTUD under your project's specific criteria. The data contained in this web site will provide guidance in a variety of assemblies and loading criteria, based on current building codes.

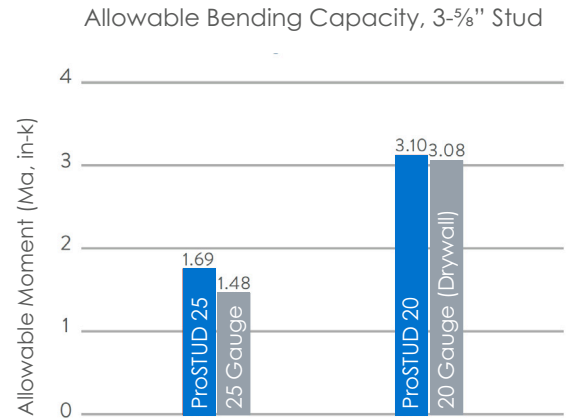

## CONNECTIONS

In addition to sufficient member strength, it's important to know how connections will perform. Connections can be critical to the capacity and safety of an assembly, but they are also important for the attachment of cabinets, shelving, handrails, and other accessories to steel framing. The tables below compare the screw performance of ProSTUD to conventional drywall framing. This performance relationship to conventional studs can be applied to a variety of fasteners and connections.

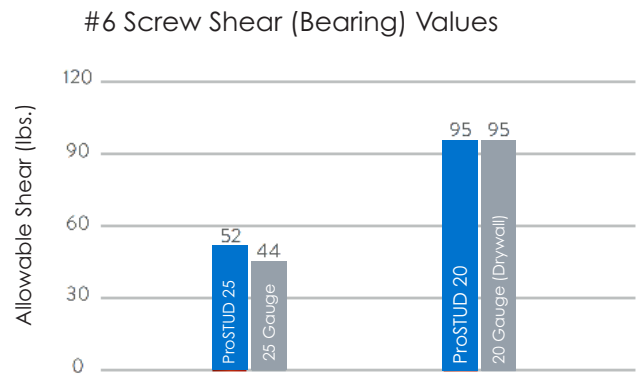
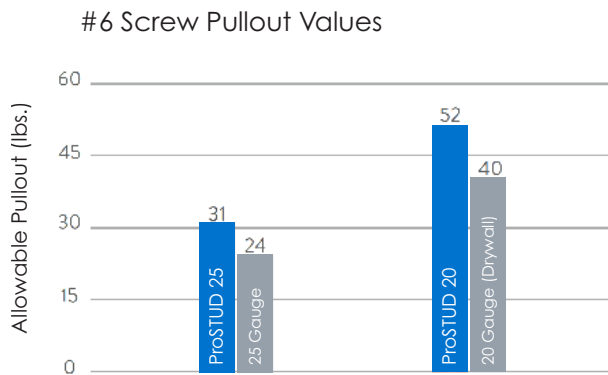

Along with connection capacity, conventional framing members are required to meet performance criteria for screw spinout. ProSTUD was developed with screw performance in mind. High-strength steel, flange stiffening grooves, web embossments, and knurling features combine to provide the best performance per thickness, exceeding the requirements of ASTM C645.

# STRUCTURAL FRAMING



ICC ESR-4205 ACCREDITED



IBC-2021 COMPLIANT

## STUD AND JOIST

Studs are a general purpose framing component used in a number of applications including exterior curtain walls, load bearing walls, headers and floor and roof joists.

## TRACK

Track is used as a closure to stud and joist ends as well as framing components to heads and sills. Note: 10' is the standard length. Custom lengths available upon request.

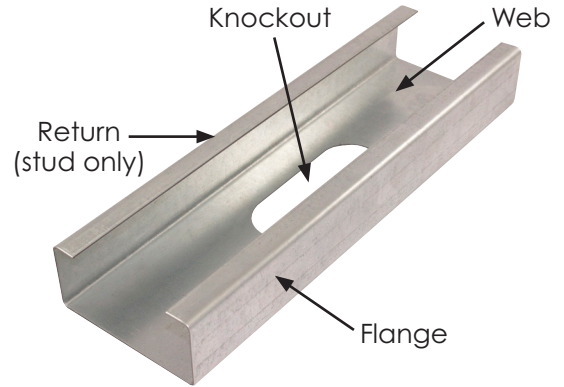

## STRUCTURAL STUD PROFILE INFORMATION

WEB WIDTHS	2 1/2"	3 5/8"	4"	6"	8"	10"	12"
FLANGE	1 5/8"	2"	2 1/2"	3"	3 1/2"		

RETURN: Varies by part

## MATERIAL THICKNESS

GAUGE	20	18	16	14	12
MILS	33 (33ksi)	43 (33ksi)	54 (50ksi)	68 (50ski)	97 (50ksi)

## WEB PUNCH-OUT SIZE AND LOCATION

Mill Steel Framing studs and joists are manufactured with punch-outs along the centerline of the web to accommodate plumbing and electrical installation. The punch-out is provided 12" from the indexed end and the intermediate punch-outs are placed at 24" o.c. intervals. The 34" by 2" punch-out is available for 2 1/2" web members only. Unpunched studs are available upon request.

Punch-Out Dimensions

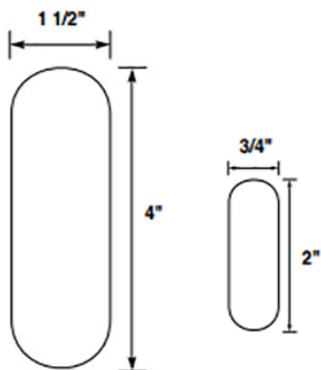

Framing Components

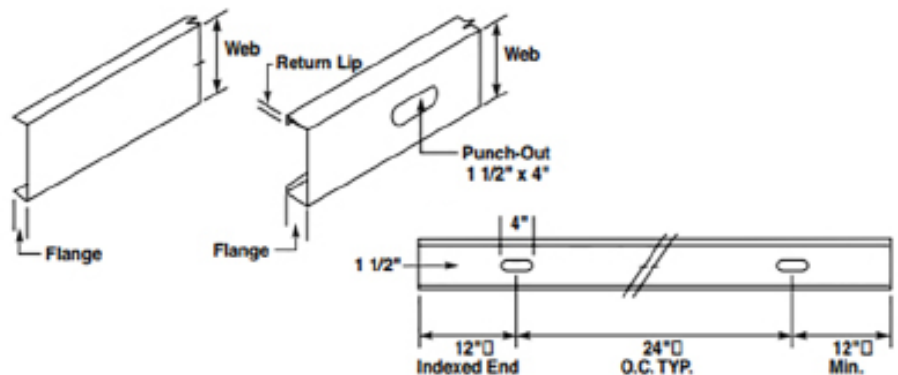

# SFIA MEMBER

Mill Steel is a founding and participating member in the Steel Framing Industry Association (SFIA). Commitment to this industry organization includes our participation in the SFIA Code Compliance Program for both non-structural and structural stud products.

## COMPARING ESR, CCRR AND SFIA CERTIFICATION

*"I already buy products with an ESR. Why would I also want them certified by the SFIA?"*

The construction products you buy, sell and install are essential elements to meeting today's building codes. Technical evaluation reports play a key role in the quality control of these products. So, you may wonder why you need something more than an Evaluation Service Report (ESR) from the ICC Evaluation Service® (ICC-ES) and or a Code Compliance Research Report (CCRR) from Intertek.

The answer? The Steel Framing Industry Association (SFIA) Code Compliance Certification Program for ColdFormed Steel Stud and Track goes one step further. SFIA Certification provides greater quality assurance.

As with ESR and CCRR certifications, SFIA Certification includes a third-party review of the product design and

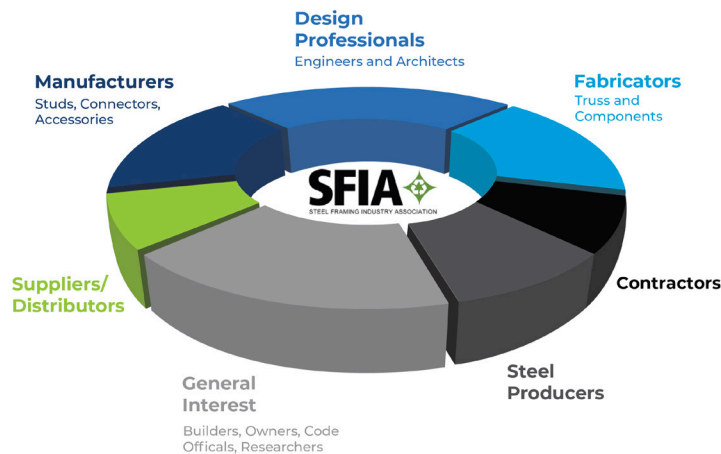

engineering data to ensure accuracy and requires that quality control procedures are in place.

SFIA Certification, however, requires random, unannounced testing of product in inventory or coming off the line twice-a-year (not just yearly). Manufacturers must document procedures and keep strict records of product tolerances and dimensions. SFIA Certification meets all relevant building codes.

Indeed, SFIA Certification provides true quality assurance and encourages continuous improvement. "SFIA Listed" is the mark carried by 84% of all metal framing products in North America.

	ESR-4205	CCRR-0224	SFIA Certification
Inspections include?	1. Process reviews yearly 2. Labeling/marketing 3. ASTM A370	1. Process reviews yearly 2. Labeling/marketing	1. Process reviews twice a year 2. Labeling/marketing (individual and bulk) 3. ASTM A370 Mechanical Testing, ASTM A90 Coating Mass Testing 4. Verification and calibration of measuring devices 5. Dimensional checks 6. Review of company quality manual 7. Review of raw materials suppliers and raw materials criteria 8. Training records 9. Best practices sharing 10. Confirmation of company contacts
Dimensional checks?	No	No	Yes
Help resolving issues?	No	Yes	Yes
Certifies equivalent nonstructural products?	No, can only certify standard products	No, can only certify standard products	
	Testing waived for SFIA Certified products listed in ESR-4205	Inspections waived for SFIA Certified products listed in CCRR-0224	